

Intelligent Systems: Reasoning and Recognition

James L. Crowley

Ensimag 2

Second Semester 2017/2018

Lesson 18

13 April 2018

Reasoning with Bayesian Networks

Bayesian Networks	2
Probability Distribution Tables	3
Joint Probability Distributions Tables.....	4
Conditional Probability Tables (CPT)	5
Factoring Distribution Tables with Bayesian Networks	6
Independent Random Variables	6
Conditional Independence.....	6
Chain Rule.....	7
Computing with Conditional Probability Tables	8
A Joint Distribution in Structured Form	10
Reasoning with Bayesian networks	11
Diagnostic Reasoning	11
Predictive reasoning	12
Intercausal Reasoning	12
Markov Blanket.....	13
Constructing a Bayesian Network.	14
The Definitional/synthesis idiom	15
The Cause-Consequence Idiom	15
The Measurement idiom	15
The Induction Idiom.....	16
The Reconciliation Idiom.....	16

Sources:

1. Koller, D., and Friedman, N., Probabilistic graphical models: principles and techniques. MIT press, 2009.
2. NEIL, Martin, FENTON, Norman, and NIELSON, Lars. Building large-scale Bayesian networks. *The Knowledge Engineering Review*, 2000, vol. 15, no 3, p. 257-284.

Bayesian Networks

Bayesian Networks are graphical models for reasoning about probabilistic variables.

In a Bayesian Network, the nodes represent random variables (discrete or continuous) and the arcs represent relations between variable. Arcs are often causal connections but can be other forms of association. Bayesian networks allow probabilistic beliefs about random variables to be updated automatically as new information becomes available.

The nodes in a Bayesian network represent the probability of random variables, X from the domain.

Directed arcs (or links) connect pairs of nodes, $X_1 \rightarrow X_2$, representing the direct dependencies between random variables.

For example: Fire causes Smoke. Let F =Fire, S =Smoke

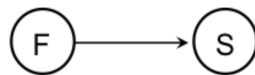

We can use graphical models to represent causal relations.

For example add a third random variable, H =Heat.

Then Fire causes Smoke and Heat would be expressed as:

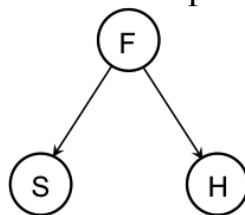

Graphical models can also express multiple possible causes for diagnostic reasoning. For example, Fire can be caused by an Electrical problem (E) or by a Cigarette (C)

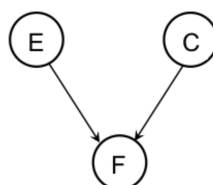

The strength of the relationship between variables is quantified by conditional probability distributions associated with each node. These are represented by Conditional Probability Tables.

Probability Distribution Tables

A **Probability Distribution Table** gives the relative frequency of occurrence for all possible values of a property (feature) for a set of observations. Properties can be Boolean, symbolic or numeric (integer or real).

Suppose that we have a set of M observations that can be divided into N subsets, such that the subsets are (1) Mutually Exclusive and (2) Complete.

For example, a set of M people can be divided into subsets defined by eye color: $C = \{\text{Blue, Green, Brown}\}$. This set is (1) Mutually Exclusive and (2) Complete.

Mutually Exclusive: Eye color can only have a one value $\{\text{Blue, Green, Brown}\}$

Complete: Eye color must have one of the values $\{\text{Blue, Green, Brown}\}$

A Probability Distribution Table gives the relative frequency of occurrence for each value of a property.

Let C represent the Eye Color $C = \{\text{blue, green, brown}\}$, $N_c = 3$.

Let $h(C)$ be a counter for the value of C . $h(C)$ is initially 0.

This can be easily implemented as a “map” that associates a key with a value.

The keys are the subset labels: $\{\text{Blue, Green, Brown}\}$

The values are the number of events with the value. $h(C)$

Capital C is the random variable for the set, lower case c is a specific value of C .

For each person E in the set S : if E is c then $h(c) \leftarrow h(c) + 1$

Formally:

$$\forall E \in S: E \in c \Rightarrow h(c) \leftarrow h(c) + 1;$$

Note that because each person can have one and only one feature value:

$$M = \sum_{c \in C} h(c)$$

A probability distribution table gives the probability that a person E in the set S has the eye color c . This can be computed from:

$$P(E \in c) = \frac{1}{M} h(c) \quad \text{This is commonly written: } P(C) = \frac{1}{M} h(C)$$

Note that to be a valid probability, the values must sum to 1:

$$1 = \sum_{c \in C} P(c)$$

Joint Probability Distributions Tables

Distribution tables can be generalized to multiple classes.

For example, the persons in the set S can have gender as well as Eye color.

Let G represent the Gender {Male, Female}. $N_G=2$

A joint distribution table counts the number of persons Eye Color, C, with a certain Gender, G. For a training set, S, with M samples:

$$\forall (c, g) \in S : h(c, g) \leftarrow h(c, g) + 1;$$

Then:
$$P(c, g) = \frac{1}{M} h(c, g)$$

The complete table must sum to 1.
$$\sum_{c \in C} \sum_{g \in G} P(c, g) = 1$$

We can eliminate a class from the table by summing a column:

$$P(C) = \sum_{g \in G} P(C, g)$$

All this can be generalized to multiple features. For three features A, B, C

$$p(A, B, C) = \frac{1}{M} h(A, B, C)$$

and

$$P(A, B) = \sum_{x \in C} P(A, B, x)$$

Graphically, probability distribution tables are displayed as:

G\C	Brown	Blue	Green
Male	0.3	0.2	0.1
Female	0.3	0.2	0.1

When reasoning with Boolean features, some authors omit the columns for False.

Conditional Probability Tables (CPT)

Bayes Rule provides a definition of conditional probability tables.

For a probability distribution $P(A,B)$ the Conditional probability can be defined as

$$P(A|B) = \frac{P(A,B)}{\sum_x P(x,B)} = \frac{P(A,B)}{P(B)}$$

With multiple features;

$$P(A,B|C) = \frac{P(A,B,C)}{\sum_{x \in C} P(A,B,x)} = \frac{P(A,B,c)}{P(A,B)}$$

For example, consider the Boolean values F=Fire and S=Smoke

$$P(\text{Fire}, \text{Smoke}) = P(\text{Smoke}|\text{Fire}) P(\text{Fire})$$

P(Smoke Fire)	Smoke	¬Smoke
Fire	0.9	0.1
¬Fire	0.001	0.999

Each row sums to one. Columns are independent.

Suppose we know a joint table $P(S, H, F)$ and we wish to compute $P(F | S)$.

$$P(F | S) = \frac{\sum_{x \in H} P(F, S, x)}{\sum_{x \in S} \sum_{y \in H} P(F, x, y)}$$

This is clumsy and expensive.

The calculation is even worse if our table includes possible causes such as an electrical Fire (E) or a Cigarette fire (C): $P(F, S, H, E, C)$. To compute $P(F|S)$ we first have to sum out all the other terms.

Bayesian networks gives a way to simplify the calculation by factoring the distribution table $P(F,S,H)$ into components.

Factoring Distribution Tables with Bayesian Networks

Bayesian Networks factor a large Probability Distribution Table (PDT) into a set of much smaller Conditional Probability Tables (CPTs).

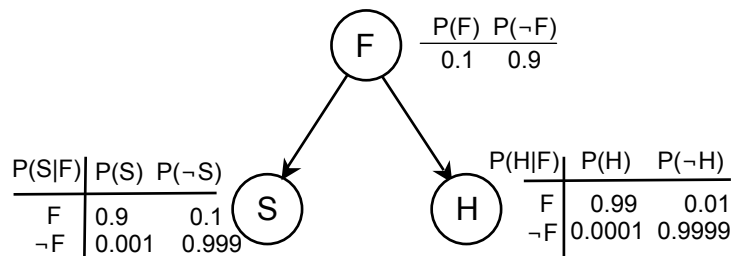

Factoring a PDT requires that the variables be conditionally independent.

Independent Random Variables

Two random variables are Independent if $P(A, B) = P(A) \cdot P(B)$

Formally, this is written: $A \perp B$

Independence implies that $P(A | B) = P(A)$

Demonstration:
$$P(A | B) = \frac{P(A, B)}{P(B)} = \frac{P(A)P(B)}{P(B)} = P(A)$$

Conditional Independence

Conditional independence occurs when observations A and B are independent given a third observations C. Conditional independence tells us that when we know C, evidence of B does not change the likelihood of A.

If A and B are independent given C then $P(A | B, C) = P(A | C)$.

Formally: $A \perp B | C \Leftrightarrow P(A | B, C) = P(A | C)$

Note that $A \perp B | C = B \perp A | C \Leftrightarrow P(B | A, C) = P(B | C)$

A typical situation is that both A and B result from the same cause, C. For example, Fire causes Smoke and Heat.

When A is conditionally independent from B given C, we can also write:

$$P(A, B | C) = P(A | B, C) \cdot P(B | C) = P(A | C) \cdot P(B | C)$$

Chain Rule

When A and B are conditionally independent given C ,

$$P(A \mid B, C) = P(A \mid C)$$

$$P(A, B \mid C) = P(A \mid C) \cdot P(B \mid C)$$

When conditioned on C , the probability distribution table $P(A, B)$ factors into a product of marginal distributions, $P(A/C)$ and $P(B/C)$.

Conditional independence allows us to factor a Probability Distribution Table into a product of much smaller Conditional Probability Tables.

Bayesian networks explicitly express conditional independencies in probability distributions and allows computation of probabilities distributions using the chain rule.

Computing with Conditional Probability Tables

Conditional independence allows us to factor a Probability Distribution into a product of much smaller Conditional Probability Tables.

For example, let F=Fire, S=Smoke and H=Heat.

$$P(F, S, H) = P(S | F) P(H | F) P(F) \text{ Factors into}$$

$$P(F, S) = P(S | F) P(F) \text{ and } P(F, H) = P(H | F) P(F)$$

Each factor is described by a Conditional Probability Table.

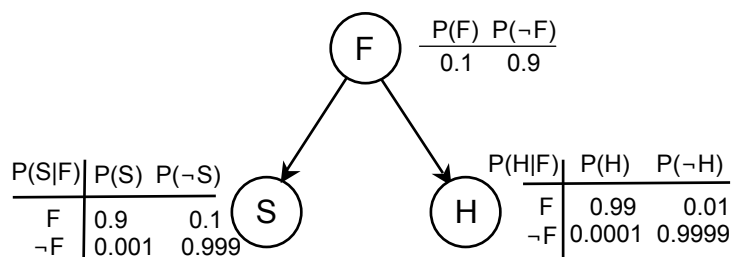

Each row of the table must sum to 1. To simplify the table, most authors do not include the last column. The values for last column are determined by subtracting the sum of the other columns from 1.

Arcs link a "Parent node" to a "Child Node). F → S Fire is Parent to Smoke

This is written Parent(S) = F

The set of all parents of a node x is the function Parents(x).

In General
$$P(X_1, X_2, \dots, X_D) = \prod_n P(X_n | \text{parents}(X_n))$$

We can use the network to answer questions. For example:

What is the probability of fire if we see smoke?

$$P(F|S) = \frac{P(F,S)}{P(S)}$$

For this we need the joint probability of fire and smoke, $P(F,S)$ as well as $P(S)$

Bayesian Networks

If we were using the full PDT, we would be required to compute the joint probability by summing out terms H and F in the table $P(F,S,H)$.

$$P(F,S) = \sum_H P(F,S,H) \quad \text{and} \quad P(S) = \sum_F \sum_H P(F,S,H)$$

The graph provides a direct solution using only $P(F,S)$

$$P(F,S) = P(S|F)P(F) = 0.9 \cdot 0.1 = 0.09$$

and

$$P(S) = P(F,S) + P(\neg F,S) = 0.9 \cdot 0.1 + 0.001 \cdot 0.9 = 0.0909$$

Thus

$$P(F) = \frac{P(F,S)}{P(S)} = \frac{0.09}{0.0909} = 0.99$$

In a larger problem the full PDT would have been MUCH larger.

A Joint Distribution in Structured Form

A Bayesian Network is a Joint Distribution in Structured form. The network is an Acyclic Directed Graph.

Dependence and independence are represented as a presence or absence of edges:

Node = random Variable

Directed Edge = Conditional Dependence

Absence of an Edge = Conditional Independence.

The graph shows conditional (and causal) relations. When you specify a graph, you obtain a formula. Common structures are:

Marginal Independence:

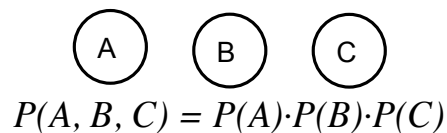

Markov Dependence (Causal Chain)

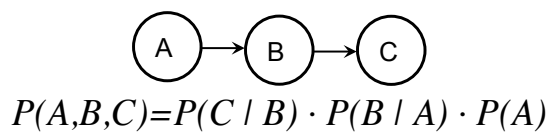

Independence Causes: (Common Effect)

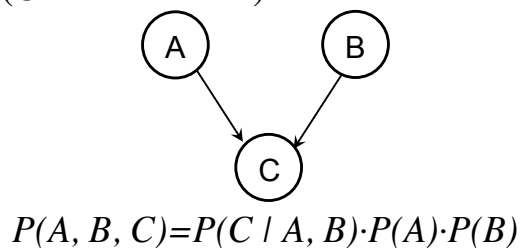

Common Cause

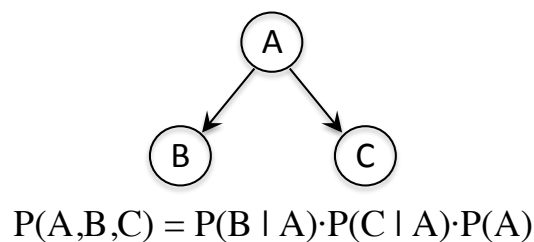

Arcs link a "Parent node" to a "Child Node).

A is the Parent of B. This is written

$A \rightarrow B$

$\text{Parent}(B) = A$

Bayesian Networks

The set of all parents of a node x is the function $\text{Parents}(x)$.

In General
$$P(X_1, X_2, \dots, X_D) = \prod_n P(X_n | \text{Parents}(X_n))$$

A series of arcs list ancestors and descendents $A \rightarrow B \rightarrow C$

Node A is an ancestor of C. Node C is a descendent of A.

Reasoning with Bayesian networks

Bayesian networks support several types of reasoning.

Reasoning (inference) occurs as a flow of information through the network. This is sometimes called propagation or belief updating or even conditioning.

Note that information flow is *not* limited to the directions of the arcs.

Diagnostic Reasoning

Diagnostic reasoning is reasoning from symptoms to cause

Diagnostic reasoning occurs in the *opposite* direction to the network arcs.

Example: A fire (F) can be caused by an electrical problem (E) or a Cigarette (C)
The fire causes smoke (S) and Heat (H).

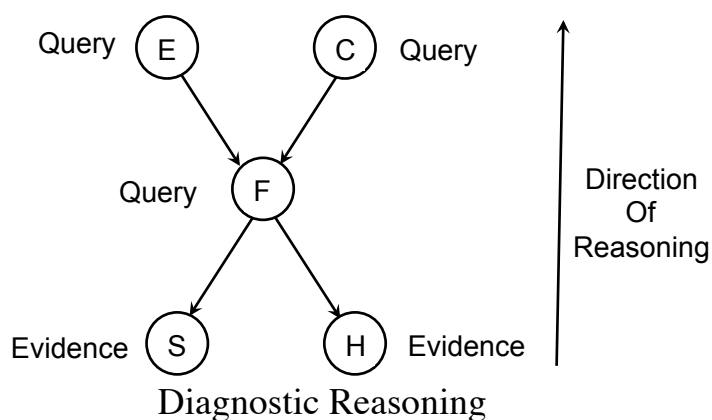

Predictive reasoning

If we discover an electrical problem, we can predict that it caused the fire.

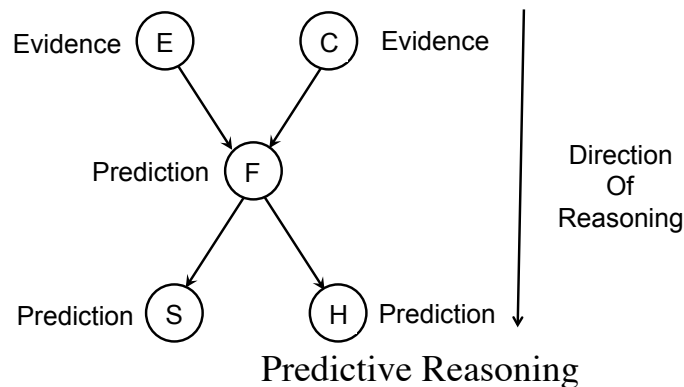

Note that “prediction” is not a statement about time, but about “estimation of likelihood”. Predictive reasoning is reasoning from new information about causes to new beliefs about effects, following the directions of the network arcs.

Intercausal Reasoning

Intercausal reasoning involves reasoning about the mutual causes of a common effect. Suppose that there are exactly two possible causes of a particular effect, represented by a v-structure in the BN.

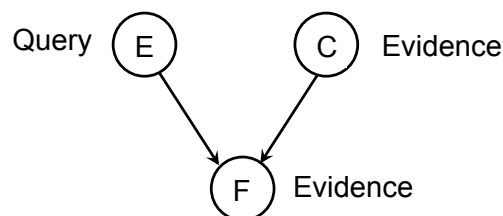

For example, a fire (F) could be caused an electrical problem (E) or a cigarette (C).

Initially these two causes are independent. Suppose that we find evidence of a smoking. This new information explains the fire, which in turn *lowers* the probability that the fire was caused by an electrical problem. Even though the two causes are initially independent, with knowledge of one cause the alternative cause is *explained away*.

The Parent nodes become dependent given information about the common effect. They are said to be conditionally dependent

$$P(E | F, C) \neq P(E | F) \Rightarrow E \perp\!\!\!\perp C | F$$

For example, suppose that you observe that there is a traffic Jam. This may be caused by a train-strike, or by roadwork. If you then discover that there is a demonstration of train workers. This confirms the trains are on strike, and explains away the possibility that roadwork has caused the traffic jam.

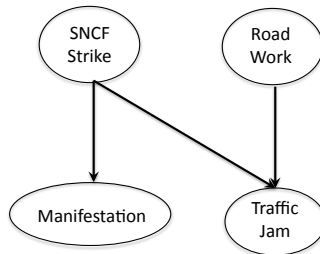

Markov Blanket

The Markov blanket of a node contains all the variables that shield the node from the rest of the network. This means that the Markov blanket of a node is the only knowledge needed to predict the behavior of that node. The children's parents are included, because they can be used to explain away the node in question.

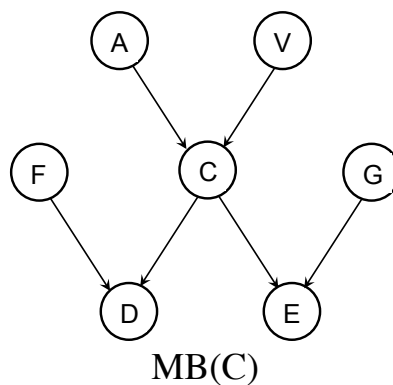

Constructing a Bayesian Network.

Bayesian networks are generally constructed using object oriented programming. Common network patterns are coded as objects. The programmer then chains objects together. However designing a network for real problems remains somewhat of an art, and is the subject of research.

Most textbooks present only simple, pedagogically useful examples. Building real networks for practical applications is a difficult challenge.

The problems of building a complete BN for a large problems involves solving two different problems.

- 1) build the graph structure and
- 2) define the node probability tables for each node of the graph.

Building the graph structure is the hard part. This is partly because most conditional relations can be coded in several different ways. There are no obvious rules about to structure the network.

Once the network is defined, the probabilities can often be determined from statistics.

To design the network structure, researchers have assembled dictionaries of common network fragments, and expressed this using object oriented programming. These fragments are called "idioms". They represent commonly found reasoning structures.

Building a network is then reduced to assembling the objects that represent the appropriate idioms.

Five popular idioms are:

1. The Definitional/synthesis idiom
2. The Cause-Consequence Idiom
3. The Measurement idiom
4. The Induction Idiom
5. The Reconciliation Idiom

The Definitional/synthesis idiom

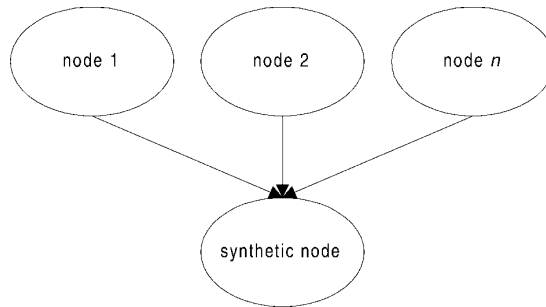

The definitional/synthesis idiom models the synthesis or combination of many nodes into one node for the purpose of organising the BN. Definitional/synthesis idiom also model the deterministic or uncertain definitions between variables;

The Cause-Consequence Idiom

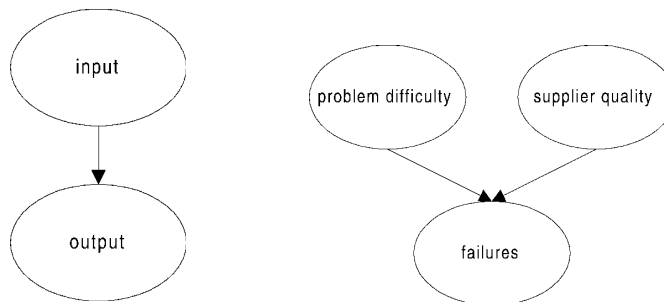

$$P(\text{test quality} \mid \text{complexity, competence}).$$

The cause-consequence idiom models the uncertainty of an uncertain causal process with observable consequences; The cause-consequence idiom is used to model a causal process in terms of the relationship between its causes (those events or facts that are inputs to the process) and consequences (those events or factors that are outputs of the process). The causal process itself can involve transformation of an existing input into a changed version of that input or by taking an input to produce a new output. We use the cause-consequence idiom to model situations where we wish to predict the output(s) produced by some process from knowledge of the input(s) that went into that process.

The Measurement idiom

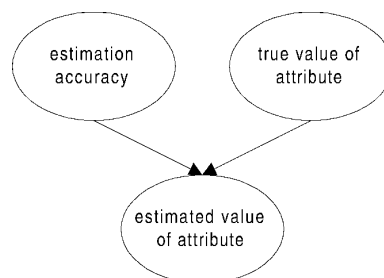

$$P(\text{test results} \mid \text{risk, test quality})$$

Bayesian Networks

The measurement idiom models the uncertainty about the accuracy of a measurement instrument; The measurement idiom represents uncertainties we have about the process of observation. By observation we mean the act of determining the true attribute, state or characteristic of some entity. The difference between this idiom and the cause-consequence idiom is that here one node is an estimate of the other rather than each representing attributes of two different entities.

The Induction Idiom

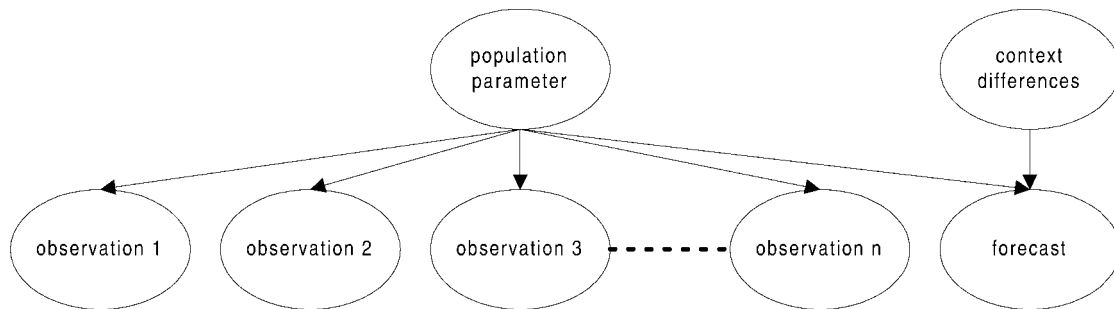

The Induction Idiom models the process of statistical inference from a series of similar entities to infer something about a future entity with a similar attribute. None of the reasoning in the induction idiom is causal. Specifically, the idiom has two components:

1. It models Bayesian updating to infer the parameters of the population where the entities from this population are assumed to be exchangeable.
2. It allows the expert to adjust the estimates produced if the entity under consideration is expected to differ from the population, i.e. if it is not exchangeable because of changes in context.

The Reconciliation Idiom

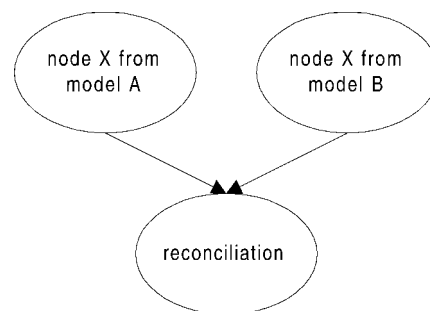

The reconciliation Idiom reconciles independent sources of evidence about a single attribute of a single entity, where these sources of evidence have been produced by different measurement or prediction methods (i.e. other BNs).